



**FIAMMA**  
first choice

*Many interesting  
accessories for your  
Ducato Van Conversion...  
and holidays  
are more  
comfortable*

Fiamma for  
Ducato

fiamma.com



**The compact awning of Italian design**

The easy-to-use and simple to install awning which combines today's best technologies, service and quality. Constantly renewed, the F45s awning is compact and functional, making it the best choice for your holidays! When not in use, the F45s takes up little space while snugly enclosed in its aluminium case. Sturdy and safe to operate, with an easy to hook winch loop.



Choosing guide

- Winch opening and closing. Operation by handle  
Electric motor optional
- Wall installation with standard brackets included
- Designed for motorhome, caravan, van conversion and campervan
- Lengths from 190 to 450
- Different canopy and case finishes available

Canopy finishes

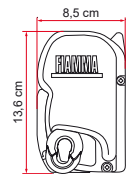
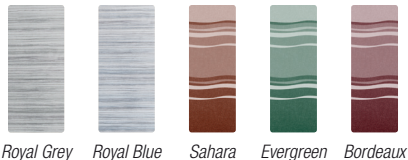

Case finishes

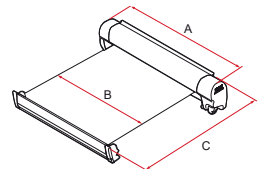



## Optional enclosures and accessories



### Range of accessories:

- Motor Kit
- LED
- Rafter
- Tie Down S
- Kit Rain Guard
- Kit Awning Hangers
- Shade Sun View

### Enclosures:

- Privacy Room
- Privacy Room Light
- Privacy Ultra Light

### Front and side panels:

- Blocker Pro
- Blocker
- Sun View XL
- Side W Pro
- Side W Pro Shade
- Sun View Side



## F45s on Fiat Ducato: the wall installation awning for Ducato Van conversions

Fiat Ducato	Vehicle height	Vehicle length	Awning	Adapter
Aftert 1994 before 2006	H2 (2470 mm)	L2 (5099 mm)	F45s 300	98655-680
	H2 (2470 mm)	L3 (5599 mm)	F45s 350	98655-680
After 06-2006	H2 (2470 mm)	L2 (5413 mm)	F45s 300	98655-755
	H2 (2470 mm)	L3 (5998 mm)	F45s 350	98655-755
	H2 (2470 mm)	L4 (6363 mm)	F45s 400	98655-755 (x2)

## Models and dimensions

Description	Item No.	Fabric colours	Awning length A	Canopy length B	Shade surface	Weight
F45s 300 Polar White	06280A01(X)	R-Q-S-E-D	308 cm	292 cm	7,3 m <sup>2</sup>	23 kg
F45s 350 Polar White	06280B01(X)	R-Q-S-E-D	348 cm	331 cm	8,3 m <sup>2</sup>	25 kg
F45s 300 Titanium	06290A01(X)	R-Q	308 cm	292 cm	7,3 m <sup>2</sup>	23 kg
F45s 350 Titanium	06290B01(X)	R-Q	348 cm	331 cm	8,3 m <sup>2</sup>	25 kg
F45s 300 Deep Black	06759A01R	R	308 cm	292 cm	7,3 m <sup>2</sup>	23 kg
F45s 350 Deep Black	06759B01R	R	348 cm	331 cm	8,3 m <sup>2</sup>	25 kg

### Extension: 250 cm

Specify the fabric colour you want when ordering by replacing (X) with:  
R=Royal Grey, Q=Royal Blue, S=Sahara, E=Evergreen, D=Bordeaux



**The roof awning with compact dimensions: strong structure and low weight!**

It perfectly fits onto the vehicle without overhanging.  
 Solid end caps in aluminium.  
 Perfect for motorhomes, caravans and van conversions.  
 The ideal solution for roof installation.



Choosing guide

- Winch opening and closing. Operation by handle.
- Electric motor optional
- Roof installation
- Installation brackets optionally available
- Suitable for motorhome, caravan and van conversion
- Lengths from 290 to 400
- Different canopy and case finishes available

Canopy finishes



Royal Grey    Royal Blue

Case finishes



Polar White    Titanium    Deep Black

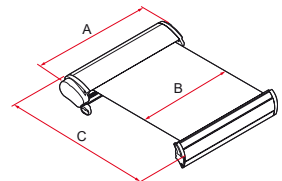
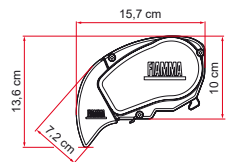



## Optional enclosures and accessories



### Range of accessories:

- Motor Kit
- LED
- Rafter
- Tie Down S
- Kit Rain Guard F65
- Kit Awning Hangers
- Shade Sun View

### Enclosures:

- Privacy Room
- Privacy Ultra Light

### Front and side panels:

- Blocker Pro
- Blocker
- Sun View XL
- Side W Pro
- Side W Pro Shade
- Sun View Side



## F45s on Fiat Ducato: the roof installation awning for Ducato Van conversions

Fiat Ducato	Vehicle height	Vehicle length	Awning	Adapter
Before 06-2006	H2 (2524 mm)	L2 (5099 mm)	F65s 290	98655-373 or 98655-693
		L3 (5599 mm)	F65s 340	98655-373 or 98655-693
After 06-2006	H2 (2524 mm)	L2 (5416 mm)	F65s 320	98655-745
		L3 (5998 mm)	F65s 370	98655-745
		L4 (6363 mm)	F65s 400	98655-904
	H3 (2764 mm)	L2 (5416 mm)	F65s 320	98655-656
		L3 (5998 mm)	F65s 370	98655-656
		L4 (6363 mm)	F65s 400	98655-656

## Models and dimensions

Description	Item No.	Fabric colours	Awning length A	Canopy length B	Shade surface	Weight
F65s 290 Polar White	05810A01(X)	R-Q	290 cm	278 cm	5,6 m <sup>2</sup>	25,5 kg
F65s 320 Polar White	05810B01(X)	R-Q	320 cm	308 cm	7,7 m <sup>2</sup>	27,5 kg
F65s 340 Polar White	05810C01(X)	R-Q	340 cm	328 cm	8,2 m <sup>2</sup>	28 kg
F65s 370 Polar White	05810D01(X)	R-Q	370 cm	358 cm	9 m <sup>2</sup>	30 kg
F65s 400 Polar White*	05810E01(X)	R-Q	400 cm	388 cm	9,7 m <sup>2</sup>	32 kg
F65s 290 Titanium	05812A01(X)	R-Q	290 cm	278 cm	5,6 m <sup>2</sup>	25,5 kg
F65s 320 Titanium	05812B01(X)	R-Q	320 cm	308 cm	7,7 m <sup>2</sup>	27,5 kg
F65s 340 Titanium	05812C01(X)	R-Q	340 cm	328 cm	8,2 m <sup>2</sup>	28 kg
F65s 370 Titanium	05812D01(X)	R-Q	370 cm	358 cm	9 m <sup>2</sup>	30 kg
F65s 400 Titanium*	05812E01(X)	R-Q	400 cm	388 cm	9,7 m <sup>2</sup>	32 kg
F65s 290 Deep Black	05811A01R	R	290 cm	278 cm	5,6 m <sup>2</sup>	25,5 kg
F65s 320 Deep Black	05811B01R	R	320 cm	308 cm	7,7 m <sup>2</sup>	27,5 kg
F65s 370 Deep Black	05811D01R	R	370 cm	358 cm	9 m <sup>2</sup>	30 kg
F65s 400 Deep Black*	05811E01R	R	400 cm	388 cm	9,7 m <sup>2</sup>	32 kg

\* 1 Rafter included. Specify the fabric colour you want when ordering by replacing (X) with: R=Royal Grey and Q=Royal Blue

Extension: 200cm for the awning length 290, 250cm from the length 320 to 400cm

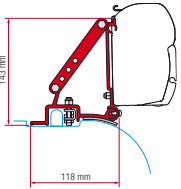

## KIT FIAT DUCATO H2

After 1994  
Before 06/2006

2 pcs. 8cm brackets  
98655-680

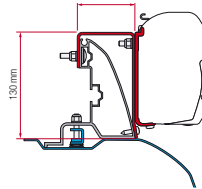

## KIT FIAT DUCATO H2 ROOF RAIL Alu-line Style

After 06/2006

3 pcs. 12cm brackets  
98655-625

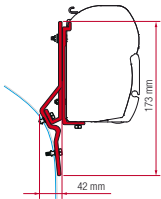

## KIT FIAT DUCATO

After 1984  
Before 1998

2 pcs. 14cm brackets  
98655-286

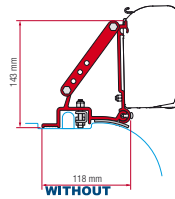

## KIT FIAT DUCATO H2

After 06/2006

2 pcs. 8cm brackets  
98655-755

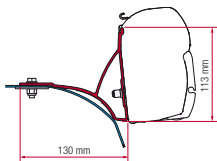

## KIT FIAT DUCATO with ROOF RACK

After 06/2006

3 pcs. 12cm brackets  
98655-485

## Accessories

### MOTOR KIT for F45s and F65s awnings

Fiamma offers you the optional 12V Motor Kit that can be installed on your awning even after mounting. The Motor Kit also allows manual opening and closing in override mode. The standard Motor Kit extends the total length of the awning by about 13cm; while the integrated Motor Kit doesn't increase the total length of the awning. The integrated Motor Kit can be easily installed by taking the cap off the manual winch. If the engine stops working (for example due to lack of current), the patented version is complete with integrated manual emergency override, operable in one minute. Control System delivered as standard.

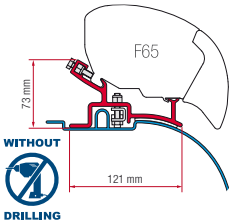

## KIT FIAT DUCATO H2

After 1994  
Before 06/2006

2 pcs. 20cm brackets  
98655-373

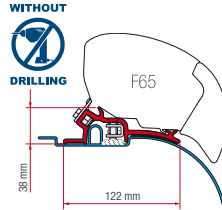

## KIT FIAT DUCATO H2

After 1994  
Before 06/2006

2 pcs. 20cm brackets  
98655-693

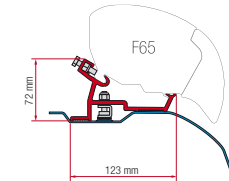

## KIT FIAT DUCATO H2

After 06/2006,  
for L2 and L3

2 pcs. 20cm brackets  
1 pc. 12cm bracket  
98655-745

Brackets equipped with 300 cms of rubber seal.  
For F65 370 awning install also the Kit Rain Guard F65 50 optional (see page 8 [1])

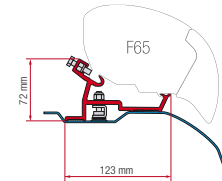

## KIT FIAT DUCATO HIGH ROOF SUPER LONG

After 06/2006, for L4

2 pcs. 26cm brackets  
1 pc. 12cm bracket  
98655-904

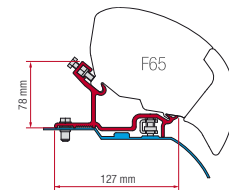

## KIT FIAT DUCATO H3

After 06/2006

1 pc. 20cm bracket  
1 pc. 25cm bracket  
1 pc. 35cm bracket  
98655-656

Description	Item No.	Weight
Motor Kit F45s Polar White	06275-01-	2,6 kg
Motor Kit F45s Titanium	06275-01T	2,6 kg
Motor Kit F65s Polar White	06536-01-	2,6 kg
Motor Kit F65s Titanium	06536-01T	2,6 kg
Motor Kit F65s Integrato	05823-01-	1,1 kg



# Accessories



## RAIN GUARD RUBBER SEALS

**[1]** Convenient rubber guard to seal the space between the awning and the vehicle wall to prevent water infiltration. Three versions available for Ducato: Kit Rain Guard F65, Kit Rain Guard Van and Rain Guard Lower.

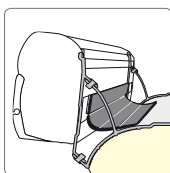
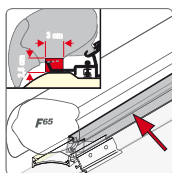
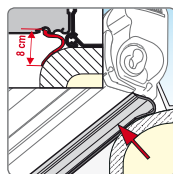

## RAIN GUARD LOWER

For awnings F45s with suspended installation spaced from the wall. Installation in the special guide of the case.

## KIT RAIN GUARD F65

Covers the whole space between the roof and the awning. Made of strong EPDM. Two Kits available: 450cm. long (standard delivered with 98655-745) and 50cm long.

## KIT RAIN GUARD VAN

For awnings F45s installed on Campervans spaced out from the wall. Length 300 cm.

## TIE DOWN

**[2]** Useful strap to keep the awning firmly anchored to the ground in light wind. It fits crank awnings up to 600cm in length.

## TIE DOWN S

**[3]** Strap kit allowing a solid anchoring of the awning to the ground. Fits into the awning guide (of F45 and F65) or the side clip of the Privacy-Room.

## KIT AWNING PLATE

**[4]** Ideal for fixing front legs to the ground, in order to increase the resistance in case of strong wind.

Description	Item No.	Rail length	Weight
<b>[1]</b> Kit Rain Guard F65	98655-020	450 cm	1,10 kg
<b>[1]</b> Kit Rain Guard F65 50	98655Z019	50 cm	0,10 kg
<b>[1]</b> Kit Rain Guard Van	98655-947	300 cm	0,80 kg
<b>[1]</b> Rain Guard Lower	06299-01-	a metro	0,35 kg/m
<b>[1]</b> Kit Rain Guard Lower 550	98655Z017	550 cm	1,9 kg
<b>[2]</b> Tie Down Yellow	98655-128		1,2 kg
<b>[2]</b> Tie Down Black	98655-129		1,2 kg
<b>[3]</b> Tie Down S Yellow	98655-567		1,2 kg
<b>[3]</b> Tie Down S Black	98655-133		1,2 kg
<b>[4]</b> Kit Awning Plate	98655-724		0,3 kg





Special version of the awning F65eagle designed for installation on the roof of Fiat Ducato van conversions

F65eagle Ducato model is available for installation exclusively on Fiat Ducato, Citroën Jumper and Peugeot Boxer vehicles H2 after 2006, L2, L3 and L4 lengths.

The awning comes complete with dedicated adapter for installation on the vehicle.



### Choosing guide

- 12V motorized legless awning (winch automated) equipped with wind sensor
- Roof installation
- Delivered as standard with dedicated adapter
- Perfect for motorhome and van conversion
- Lengths from 319 to 399
- Canopy Royal Grey and different case finishes

### Canopy finish



Royal Grey

### Case finish



Polar White

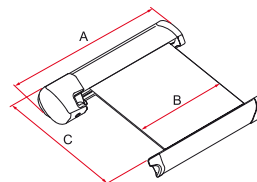
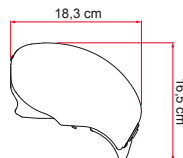

### Models and dimensions

Description	Item No.	Fabric colours	Awning length A	Canopy length B	Shade surface	Weight
F65Eagle Ducato 319 Polar White	06705F01R	R	320 cm	285 cm	7,2 m <sup>2</sup>	30 kg
F65Eagle Ducato 369 Polar White	06705G01R	R	370 cm	335 cm	8,3 m <sup>2</sup>	34 kg
F65Eagle Ducato 399 Polar White	06705H01R	R	405 cm	369 cm	9,2 m <sup>2</sup>	37 kg

**Extension: 250 cm.** Telo: R=Royal Grey

Important: verify with your trusted dealer if your motorhome or motorcaravan is suitable for the installation of the F65eagle.

The vehicle must be robust enough to support the weight and the tension of the open awning. Fiamma refuses all responsibility for damages to the roofs or for water ingress due to incorrect installation or due to installations on weak roofs

# Privacy ultra light



## The cool and ultra light Privacy that can be assembled in just a moment

Its speed of installation and mounting versatility, on straight or shaped wall, together with its ease of use make this product particularly interesting for short stays, weekends and for those who like to move fast. Particularly suitable for use in the warmer seasons.

Light, durable and quick to assemble

### Ripstop fabric, quality guaranteed

Privacy Ultra Light is made from Ripstop material, a lightweight and tear-resistant fabric. The mesh of the Ripstop fabric is characterized by a weave of threads through different sections that create strength and sturdiness, whilst remaining light. The characteristic of lightness allows the user to carry out assembly quickly and easily. Installation can easily be carried out by just one person.

Ventilated roof for optimal temperature

### Improved comfort

The double roof, (the awning fabric and the Ripstop Privacy roof) creates an air chamber with constant ventilation thus lowering the temperature inside the Privacy. The side panels can be completely rolled up to offer greater comfort and coolness and are both equipped with mosquito nets.

Great versatility

### Possibility to increase the shade surface

The Privacy Ultra Light allows you to fully open the side panels extending the shade surface.





## Delivered as standard with

- 1x complete Privacy composed of a roof, sides and front in one piece
- 1x curtain kit for the window of the front panel
- 1x Installation kit for Fiamma awnings
- 1x Kit Support cross rafters
- 1x Pegs and elastic kit
- 1x Transport bag (Mega Bag for models 400 and 450, mega Bag Light for models Van 260, 300 and 350)

*Curtains delivered as standard*



## Optional accessories

- Rafter: tensioner to increase stability
- **[1]** Kit Poles: vertical poles for Side opening
- Door Pole: vertical pole to reinforce the door
- Privacy Rail Kit: 4 rails 100cm each. for the installation of the Organizer range (S, L, Shoes and Toiletry) inside the Privacy Room

## Models and dimensions

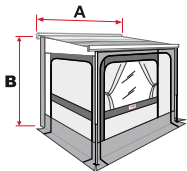

*Privacy Ultra Light 300*

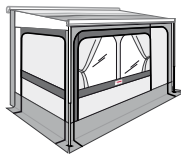

*Privacy Ultra Light 350*



*Privacy Ultra Light 400*

Description	Item No.	Awning	F45	F65	Awning length A	Height from ground B	Weight
Privacy Ultra Light 300	07350-01-	F45/F65	300	320	300/320 cm	230-280 cm	14,2 kg
Privacy Ultra Light 350	07350-02-	F45/F65	350	370	350/370 cm	230-280 cm	15,4 kg
Privacy Ultra Light 400	07350-03-	F45/F65	400	400	400 cm	230-280 cm	16,6 kg

# Privacy Room



## Delivered as standard with

- 1x Front panel with door and window with mosquito net
- 2x Side panels with windows with mosquito net
- 1x Curtain kit for all the windows of the enclosure
- 1x Fast Clip installation kit (2+2 aluminium tension poles)
- 1x Kit elastic ropes with quick hooks
- 1x Mega Bag, dim. 140x27x40cm.

**Curtains delivered as standard**

## In fifteen minutes you double your living space

The classic Fiamma enclosure suitable for all seasons. This kind of fastening ensures stability even for medium and long stays. Elegant and modern design with widened windows, all opening, equipped with mosquito net and curtains. With the Privacy Room you have a living and shaded area, ventilated or closed according with your needs.

The Privacy Room for F65s/L awning is produced in the standard length of 3.20m. Additional zip panels of 20, 50 and 80cm length are available to enlarge the front panel of the Privacy Room so as to fit F65 awnings 3.40, 3.70 and 4.00m length.

## Models and dimensions

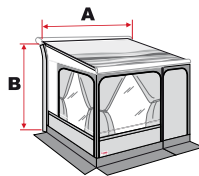

Privacy Room 320

Privacy Room F65s	Item No.	Awning length A	Height from ground B	Extension C	Weight
Privacy Room 320 Ducato (>06/06)	07354-01-	320 cm	245 cm	250 cm	23,2 kg
Privacy Room 320 H3 *	07355-01-	320 cm	280 cm	250 cm	24,0 kg
Pannello frontale 20 **	07363B01-	340 cm	251-280 cm	-	0,3 kg
Pannello frontale 50 **	07363E01-	370 cm	251-280 cm	-	0,7 kg
Pannello frontale 80 **	07363G01-	400 cm	251-280 cm	-	1,0 kg

\* Designed for Mercedes Sprinter, VW Crafter and Ducato H3, Fast Clip Light aluminium poles delivered as standard.

\*\* For awnings longer than 320cm and max 400cm use Privacy Room 320 with the additional Frontal Panel.

# Side & Blocker front & side panels

## BLOCKER PRO

Front panel is equipped with one large full light Crystal window and vinyl extension to the floor. Gives you more privacy and protection against the wind. Made of anti-rot vinyl, washable fabric with UV protection.

Delivered as standard with:

- elastic hooks and pegs

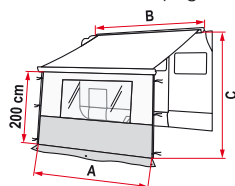

## BLOCKER

Convenient front panel that protects you from sun light and rain and gives you more privacy.

Delivered as standard with:

- ropes and pegs

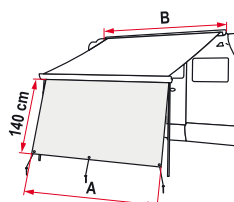

## SUN VIEW XL

Convenient front panel made with translucent light filtering material.

Can be rolled up thanks to useful fixing clips.

Delivered as standard with:

- ropes and pegs

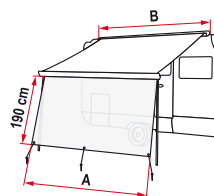

Description	Item No.	F45	F65	Length A	Awning length B	Height from ground C	Weight
Blocker Pro 280	97960-04-		●	± 255 cm	270÷290 cm	225÷280 cm	3,0 kg
Blocker Pro 300	97960-06-	●	●	± 285 cm	300÷320 cm	225÷280 cm	3,2 kg
Blocker Pro 350	97960-08-	●	●	± 335 cm	340÷370 cm	225÷280 cm	3,8 kg
Blocker Pro 400	97960-10-	●	●	± 385 cm	400÷410 cm	225÷280 cm	4,5 kg
Blocker 300	97960-20-	●	●	± 285 cm	300÷320 cm	-	2,6 kg
Blocker 350	97960-22-	●	●	± 335 cm	340÷370 cm	-	2,9 kg
Blocker 400	97960-24-	●	●	± 385 cm	400÷410 cm	-	3,3 kg
Sun View XL 300	97952-045	●	●	± 285 cm	300÷320 cm	-	2,1 kg
Sun View XL 350	97952-050	●	●	± 335 cm	340÷370 cm	-	2,3 kg
Sun View XL 400	97952-052	●	●	± 435 cm	400÷410 cm	-	2,5 kg

## SIDE W PRO

Side panel with a large full light Crystal window and vinyl extension to the floor. Made of rot-proof vinyl, washable fabric with UV protection.

Delivered as standard with:

- telescopic tension rafter
- ropes and pegs

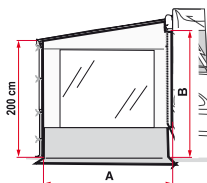

## SUN VIEW SIDE

Convenient side panel for Fiamma F45/F65 awnings. Made with translucent light filtering material. Easy to fix.

Delivered as standard with:

- telescopic tension rafter
- ropes and pegs

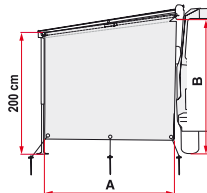

Description	Item No.	Awning	Length A	Height from ground B	Weight
Side W Pro F65 Ducato	97961-002	F65	230 cm	225÷280 cm	4,2 kg
Sun View Side	97961-05-	F45/F65	230 cm	220÷260 cm	1,4 kg

# CARRY-BIKE Van conversion



Designed for van conversions with double rear doors. Easy installation

Bike Carriers for van conversions with double rear doors. The installation of the 200DJ models drilling is necessary but only for the 4 security screws. The rear door can be opened without removing the bicycles.



Description	200 DJ Ducato > 06/2006	200 DJ Ducato < 06/2006
Item No. - red version	02093D89- <b>[renewed]</b>	02093-65-
Item No. - black version	02093D89A <b>[renewed]</b>	
Rear double door	yes	yes
Weight	9,0 kg	9,0 kg
Max load	35 kg	35 kg
Bikes carried standard	2/2	2/2
Bikes carried max	2/2	2/2
Bike-Block Pro 1 (04133-01-)		●
Bike-Block Pro 2 (04133A01-)		●
Bike-Block Pro D1 (04133E01-)	● (x2)	
Security Strip (98656-419)	●	●
Rail Premium (98656-201)	● (x2)	● (x2)
Fixing-Bar (98656-474)	●	●
Brackets	●	●

● Standard ○ Optional



Now equipped with  
Bike-Block Pro S

## 200 DJ DUCATO > 06 2006

This version allows the installation of the rail support base in two different positions, one standard and one lower to make it easier to load the bikes. Lower version must be used together with the licence plate holder bar with regulation lights, Licence Plate Carrier. Articulated brackets for a quicker removal of the bike carrier.

- Fiat Ducato after 06/2006 (H2 and H3)



Lower rail support base

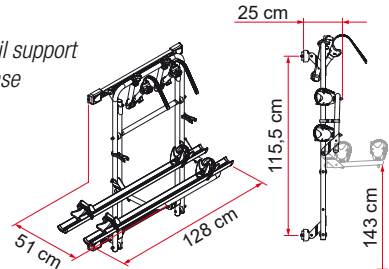

Standard rail support base

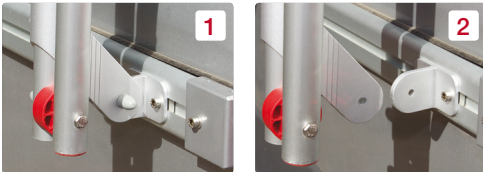
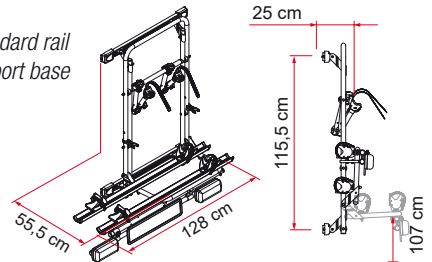

## 200 DJ DUCATO < 06 2006

- Fiat Ducato after 2000 before 06/2006
- Peugeot Boxer after 2000
- Citroën Jumper/Relay after 2000
- Mercedes Sprinter before 06/2006
- Ford Transit after 2000 before 2011

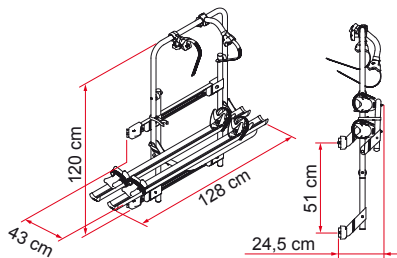

# Fixing-Bar roof racks



## ROOF RAIL DUCATO

Complete luggage carrier system designed for Ducato after 06/2006. Easy installation without drilling the vehicle, thanks to the preinstalled fixing system on the roof of Ducato.

Max. load capacity : 100 kg.

It also allows the installation of the awning F65s using the brackets that are delivered as standard (only on Ducato vehicles with H2 high roof and L2, L3 and L4 length).

What model you should choose:

- Roof Rail Ducato (05808-01-): can be installed on Ducato vehicles with H2 high roof, L1, L2 and L3 lengths (to reach the desired

length you can cut the 2 lateral bars, which are delivered as standard in L3 version)

- Roof Rail Ducato Maxi XL (05808-02-): for vehicles with H2 high roof and L4 length
- Roof rail Ducato H3 (05808-03-): version for Ducato with H3 high roof and L3 and L4 length. Delivered as standard with 4 Fixing-Bar Rail.

Additional set of 2 brackets "Kit Roof Rail Ducato Extra" (to use with 05808-02-).

Aluminium  
Quality

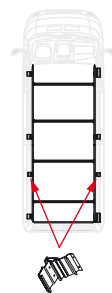
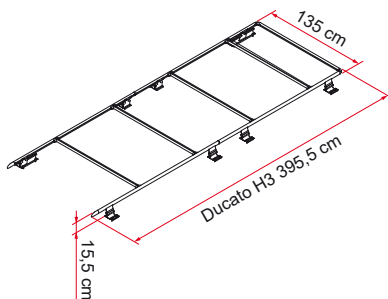
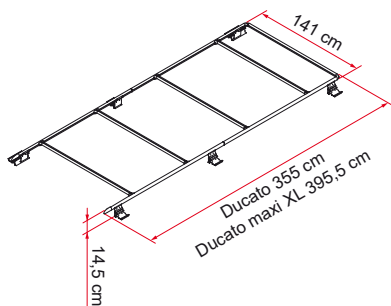

Kit Roof Rail Ducato Extra (x2)

## ROLLER ROOF RAIL

It helps loading your roof rack. It facilitates the loading of canoes, kayaks and other objects from the rear of the vehicle. Ideal to be used with Roof Rail Ducato, Roof Rail Ducato Maxi XL and with all the luggage carriers on the market, except the ones with round profiles. Not recommended for vehicles equipped with rear camera.

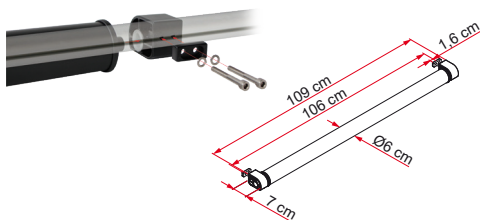

Description	Item No.	Weight
Roof Rail Ducato	05808-01-	12,0 kg
Roof Rail Ducato Maxi XL	05808-02-	13,5 kg
Roof Rail Ducato H3	05808-03-	14,2 kg
Kit Roof Rail Ducato Extra	98658-066	1,0 kg
Roller Roof Rail	06876-01-	1,5 kg



# Deluxe ladders



## High quality aluminium ladders

Deluxe DJ Ducato have Ø 30mm and 2mm thick tubes in anodized aluminium. Inner width: 28cm. Total step width: 35cm. Non-skid steps. Delivered as standard with Fixing Bars for easy and quick installation on the rear door. It can be combined with Carry-Bike 200 DJ.

Inner step width updated in accordance with the European standard UNI EN 131

## Models and dimensions

### DELUXE DJ

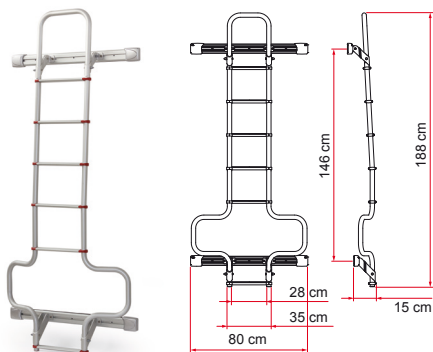

### DELUXE DJ H3

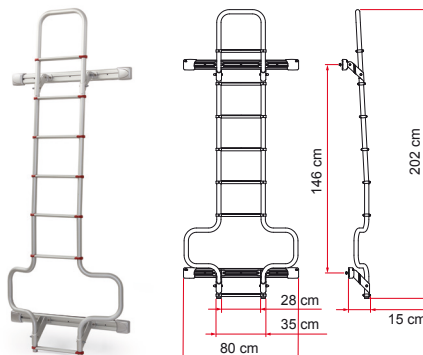

Description	Item No.	Weight	Number of steps
Deluxe DJ	02426-09-	6,5 kg	6
Deluxe DJ H3	02426-17-	6,9 Kg	7



## THERMOGLAS XXL DUCATO

**[1]** Ideal for winter use to completely cover the engine compartment.  
 Made of insulated material, suitable for low temperatures. Composed of 2 detachable parts. The upper part covers the 3 windows of the cabin; it is possible to uncover the windshield without unmounting the Thermoglas. The lower part, which can be attached with Velcro, covers the engine compartment completely. Suitable for Fiat Ducato from 06/2006.



## COVERGLAS XL DUCATO

**[2]** Blocks out the sun and protects from UV rays, gives privacy and keeps the windshield clean. Outside waterproof blind system to cover all the windows of your vehicle cabin, extended to cover bonnet air intakes as well. Easily installed: no drilling required; the cabin doors are used to support and secure the shade. This practical mounting system is secured on the inside. Useful against theft. Equipped with a convenient bag for storing the product. Size bag + product: 33x48x12cm. Excellent for summer use. Suitable for Fiat Ducato from 06/2006.



## THERMO WALL DUCATO CABIN

**[3]** Comfortable and useful thermal panel to put between the cabin and the motorhome of chassis Fiat Ducato (after 2006) to grant more privacy and heat insulation. Made in seven-layered sturdy insulated material, with the upper part in velcro and central zip-fastener for the door. Dimensions: 182x150h cm.

Description	Item No.	Weight
<b>[1]</b> Thermoglas XXL Ducato	06344A01-	11,0 kg
<b>[2]</b> Coverglas XL Ducato	06344-01-	3,5 kg
<b>[3]</b> Thermo Wall Ducato Cabin	06585A01-	1,8 kg

# Safe Door locks



## SAFE DOOR GUARDIAN

Security block designed to be placed on the inside of the door or the garage of the motorhome or caravan and to secure the front doors of the vehicle.

Excellent protection against theft as it is made of strong aluminium, without any plastic parts. It is installed instead of the standard plastic security blocks, in the same position and using the same fixing holes. 2 pieces package.



## Models and dimensions

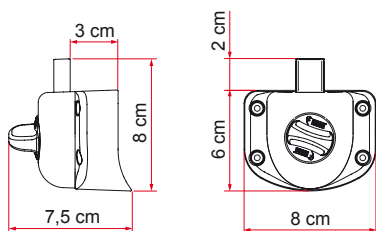

*Ducato - after 06/2006 before 09/2009*

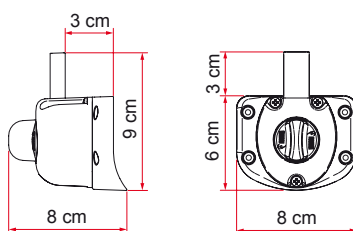

*Ducato - after 09/2009*

Description	Item No.	Weight
Safe Door Guardian Ducato after 09/2009	05388-07-	0,4 kg
Safe Door Guardian Ducato after 06/2006 before 09/2009	05388-04-	0,4 kg

# Rear Door Cover rear door enclosure



## Enclosure for the rear doors of Fiat Ducato, Citroën Jumper and Peugeot Boxer H2 after 06/2006 and Mercedes Sprinter H2 after 2006 (before 2008)

**[1]** Quick to install, supplied with side panels and front panel that can be rolled up. Rear Door Cover gives you more privacy.

The upper rafter and rail keep the fabric tight. The double rail is attached to the water gutter of the Ducato, the aluminium rafter secures the opening of the two rear doors, keeping the fabric tight. The door can be rolled up.

Delivered as standard with:

- 1x awning with side and front panels
- 1x double rail in reinforced pvc
- 1x rafter to increase stability
- 1x Kit pegs
- 1x kit of tension elastics

## Protection against wind and rain that eliminates draught

**[2]** Can be easily shortened, dimensions 497x45hcm. Delivered as standard with elastic fixing straps, wheel cover and magnets.

**[3]** Special version for protection against wind and rain for the rear doors of Fiat Ducato.

## KIT POLES



**[4]** Set of aluminium poles (Kit Poles) to extend the door as an additional canopy.

Description	Item No.	Weight
<b>[1]</b> Rear Door Cover Ducato	06357-01-	3,3 kg
<b>[2]</b> Skirting Ducato	98655-405	0,7 kg
<b>[3]</b> Rear Skirting Ducato	06469-01-	1,7 kg
<b>[4]</b> Kit Poles	06537-01-	0,7 kg